

CALDO

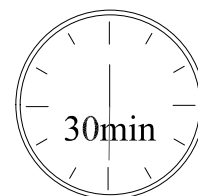

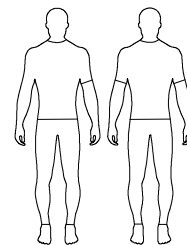

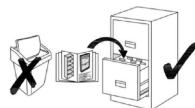
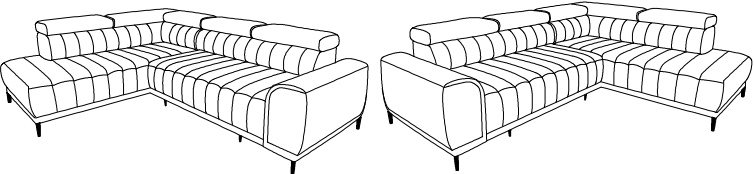
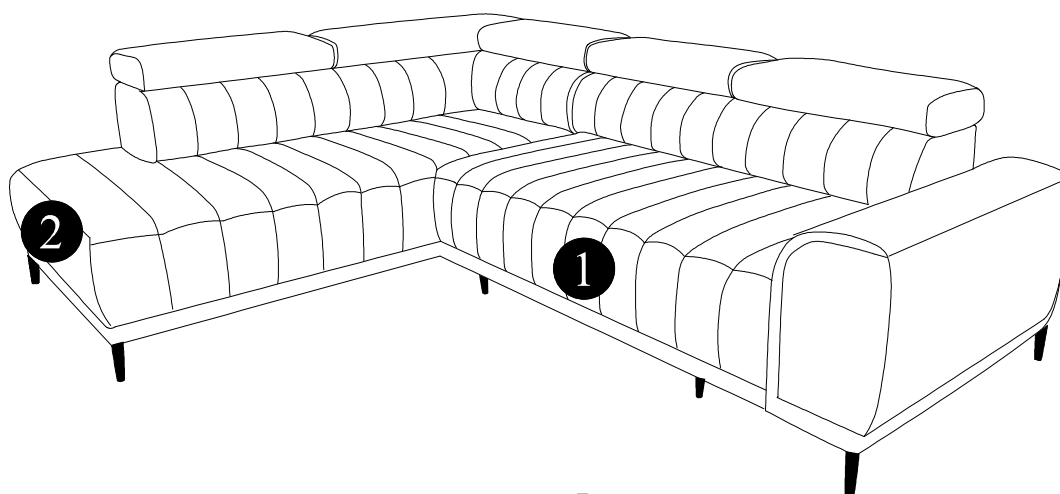

Teil	L	W	H	Pcs	Colli
1				1x	1/3
2				1x	2/3



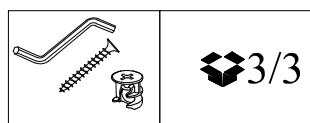
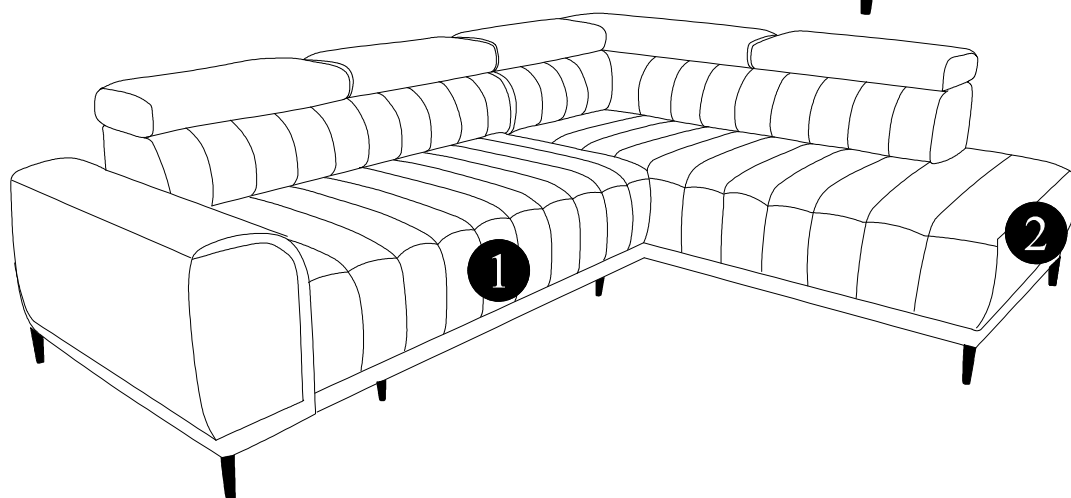

L

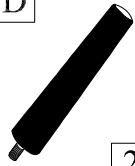
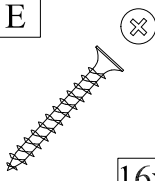
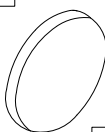

R

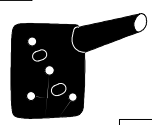

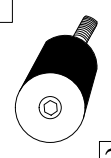
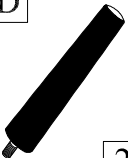
A	B	C	D	E	F
					
4x	4x	2x	2x	16x	2x
H-120	H-120	H-50	H-120	5 / 30	

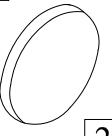
					
H-120	H-120	H-50	H-120	5 / 30	

1

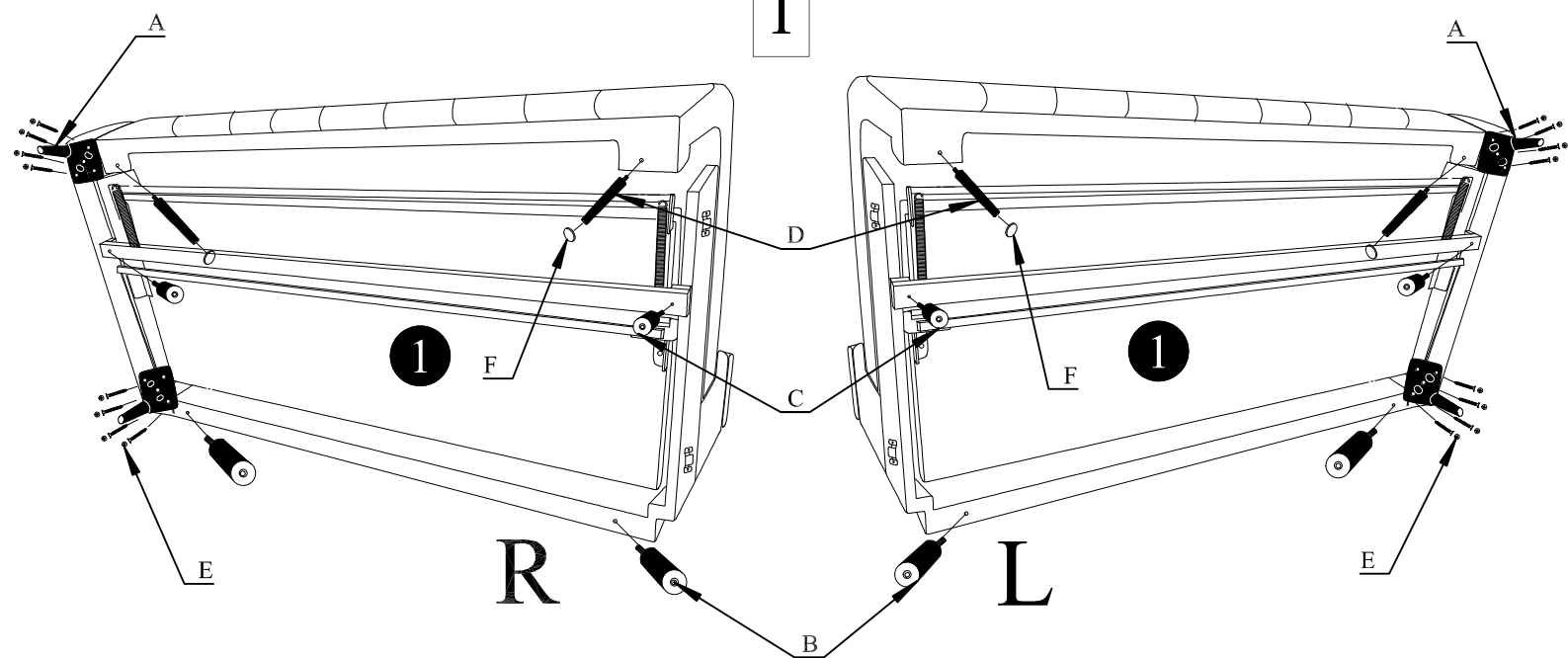

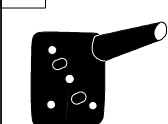
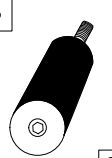
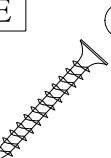
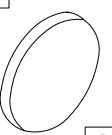
			
H-120	H-120	5 / 30	

2

R

L

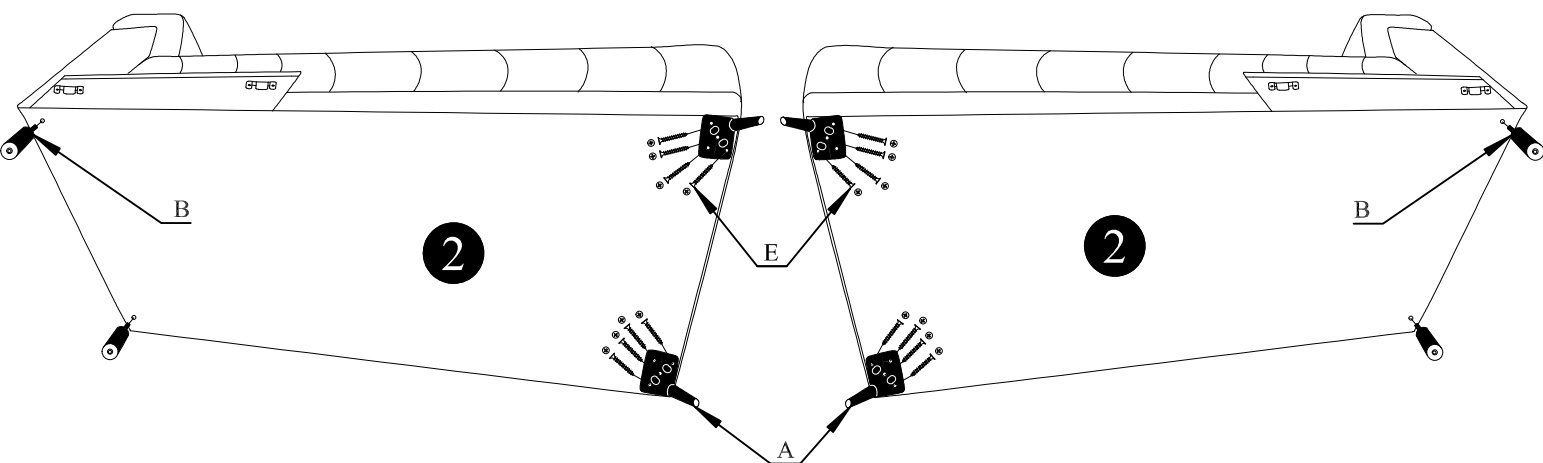

3

